

# Silicon Carbide (SiC) MOSFET - EliteSiC, 23 mohm, 650 V, M3S, TO-247-3L NVHL023N065M3S

## Features

- Typical  $R_{DS(on)} = 23\text{ m}\Omega @ V_{GS} = 18\text{ V}$
- Ultra Low Gate Charge ( $Q_{G(tot)} = 69\text{ nC}$ )
- High Speed Switching with Low Capacitance ( $C_{oss} = 153\text{ pF}$ )
- 100% Avalanche Tested
- AEC-Q101 Qualified and PPAP Capable
- This Device is Halide Free and RoHS Compliant with Exemption 7a, Pb-Free 2LI (on second level interconnection)

## Applications

- Automotive On Board Charger
- Automotive DC-DC Converter for EV/HEV

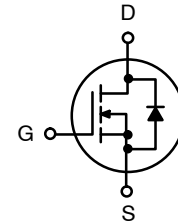
## MAXIMUM RATINGS ( $T_J = 25^\circ\text{C}$ unless otherwise noted)

Parameter	Symbol	Value	Unit
Drain-to-Source Voltage	$V_{DSS}$	650	V
Gate-to-Source Voltage	$V_{GS}$	-8/+22	V
Continuous Drain Current (Note 1)	$T_C = 25^\circ\text{C}$	$I_D$	40 A
Power Dissipation		$P_D$	263 W
Continuous Drain Current (Note 2)	$T_C = 100^\circ\text{C}$	$I_D$	40 A
Power Dissipation		$P_D$	131 W
Pulsed Drain Current (Note 3)	$T_C = 25^\circ\text{C}$ $t_p = 100\text{ }\mu\text{s}$	$I_{DM}$	218 A
Continuous Source-Drain Current (Body Diode)	$T_C = 25^\circ\text{C}$ $V_{GS} = -3\text{ V}$	$I_S$	40 A
	$T_C = 100^\circ\text{C}$ $V_{GS} = -3\text{ V}$		25
Pulsed Source-Drain Current (Body Diode) (Note 3)	$T_C = 25^\circ\text{C}$ $V_{GS} = -3\text{ V}$ $t_p = 100\text{ }\mu\text{s}$	$I_{SM}$	162 A
Single Pulse Avalanche Energy (Note 4)	$I_{LPK} = 19.6\text{ A}$ , $L = 1\text{ mH}$	$E_{AS}$	192 mJ
Operating Junction and Storage Temperature Range	$T_J, T_{stg}$	-55 to +175	$^\circ\text{C}$
Lead Temperature for Soldering Purposes (1/8" from case for 10 seconds)	$T_L$	270	$^\circ\text{C}$

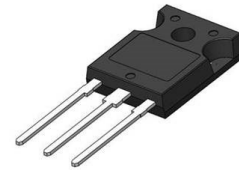
Stresses exceeding those listed in the Maximum Ratings table may damage the device. If any of these limits are exceeded, device functionality should not be assumed, damage may occur and reliability may be affected.

1. 40A is limited by package. Power chip max drain current is 70A if limited by max junction temperature.
2. 40A is limited by package. Power chip max drain current is 49A if limited by max junction temperature.
3. Repetitive rating, limited by max junction temperature.
4.  $E_{AS}$  of 192 mJ is based on starting  $T_J = 25^\circ\text{C}$ ,  $L = 1\text{ mH}$ ,  $I_{AS} = 19.6\text{ A}$ ,  $V_{DD} = 100\text{ V}$ ,  $V_{GS} = 18\text{ V}$

$V_{(BR)DSS}$	$R_{DS(ON)}$ TYP	$I_D$ MAX
650 V	23 m $\Omega$ @ $V_{GS} = 18\text{ V}$	40 A

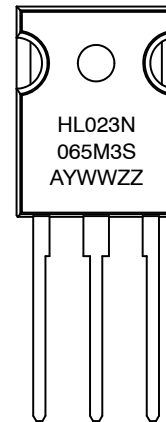


N-CHANNEL MOSFET



TO-247-3LD  
CASE 340CX

## MARKING DIAGRAM



HL023N065M3S = Specific Device Code  
A = Assembly Location  
Y = Year  
WW = Work Week  
ZZ = Lot Traceability

## ORDERING INFORMATION

Device	Package	Shipping
NVHL023N065M3S	TO-247-3L	30 Units / Tube

# NVHL023N065M3S

## THERMAL CHARACTERISTICS

Parameter	Symbol	Value	Unit
Thermal Resistance, Junction-to-Case (Note 5)	$R_{\theta JC}$	0.57	°C/W
Thermal Resistance, Junction-to-Ambient (Note 5)	$R_{\theta JA}$	40	

5. The entire application environment impacts the thermal resistance values shown, they are not constants and are only valid for the particular conditions noted.

## RECOMMENDED OPERATING CONDITIONS

Parameter	Symbol	Value	Unit
Operation Values of Gate-to-Source Voltage	$V_{GSop}$	-5...-3 +18	V

Functional operation above the stresses listed in the Recommended Operating Ranges is not implied. Extended exposure to stresses beyond the Recommended Operating Ranges limits may affect device reliability.

## ELECTRICAL CHARACTERISTICS ( $T_J = 25^\circ\text{C}$ unless otherwise specified)

Parameter	Symbol	Test Conditions	Min	Typ	Max	Unit
-----------	--------	-----------------	-----	-----	-----	------

### OFF CHARACTERISTICS

Drain-to-Source Breakdown Voltage	$V_{(BR)DSS}$	$V_{GS} = 0\text{ V}, I_D = 1\text{ mA}, T_J = 25^\circ\text{C}$	650	-	-	V
Drain-to-Source Breakdown Voltage Temperature Coefficient	$\Delta V_{(BR)DSS} / \Delta T_J$	$I_D = 1\text{ mA}$ , Referenced to $25^\circ\text{C}$	-	89	-	mV/°C
Zero Gate Voltage Drain Current	$I_{DSS}$	$V_{DS} = 650\text{ V}, T_J = 25^\circ\text{C}$	-	-	10	$\mu\text{A}$
		$V_{DS} = 650\text{ V}, T_J = 175^\circ\text{C}$ (Note 7)	-	-	500	$\mu\text{A}$
Gate-to-Source Leakage Current	$I_{GSS}$	$V_{GS} = -8/+22\text{ V}, V_{DS} = 0\text{ V}$	-	-	$\pm 1.0$	$\mu\text{A}$

### ON CHARACTERISTICS

Drain-to-Source On Resistance	$R_{DS(on)}$	$V_{GS} = 18\text{ V}, I_D = 20\text{ A}, T_J = 25^\circ\text{C}$	-	23	33	m $\Omega$
		$V_{GS} = 18\text{ V}, I_D = 20\text{ A}, T_J = 175^\circ\text{C}$ (Note 7)	-	35	-	
		$V_{GS} = 15\text{ V}, I_D = 20\text{ A}, T_J = 25^\circ\text{C}$	-	29	-	
		$V_{GS} = 15\text{ V}, I_D = 20\text{ A}, T_J = 175^\circ\text{C}$ (Note 7)	-	37	-	
Gate Threshold Voltage	$V_{GS(TH)}$	$V_{GS} = V_{DS}, I_D = 10\text{ mA}, T_J = 25^\circ\text{C}$	2	2.8	4	V
Forward Transconductance	$g_{FS}$	$V_{DS} = 10\text{ V}, I_D = 20\text{ A}$ (Note 7)	-	14	-	S

### CHARGES, CAPACITANCES & GATE RESISTANCE

Input Capacitance	$C_{ISS}$	$V_{DS} = 400\text{ V}, V_{GS} = 0\text{ V}, f = 1\text{ MHz}$ (Note 7)	-	1952	-	pF
Output Capacitance	$C_{OSS}$		-	153	-	
Reverse Transfer Capacitance	$C_{RSS}$		-	13	-	
Total Gate Charge	$Q_{G(TOT)}$	$V_{DD} = 400\text{ V}, I_D = 20\text{ A}, V_{GS} = -3/18\text{ V}$ (Note 7)	-	69	-	nC
Gate-to-Source Charge	$Q_{GS}$		-	19	-	
Gate-to-Drain Charge	$Q_{GD}$		-	18	-	
Gate Resistance	$R_G$	$f = 1\text{ MHz}$	-	4.0	-	$\Omega$

### SWITCHING CHARACTERISTICS

Turn-On Delay Time	$t_{d(ON)}$	$V_{GS} = -3/18\text{ V}, V_{DD} = 400\text{ V}, I_D = 20\text{ A}, R_G = 4.7\text{ }\Omega, T_J = 25^\circ\text{C}$ (Notes 6 and 7)	-	12	-	ns
Turn-Off Delay Time	$t_{d(OFF)}$		-	38	-	
Rise Time	$t_r$		-	30	-	
Fall Time	$t_f$		-	11	-	
Turn-On Switching Loss	$E_{ON}$		-	174	-	$\mu\text{J}$
Turn-Off Switching Loss	$E_{OFF}$		-	44	-	
Total Switching Loss	$E_{TOT}$		-	218	-	

# NVHL023N065M3S

## ELECTRICAL CHARACTERISTICS ( $T_J = 25^\circ\text{C}$ unless otherwise specified) (continued)

Parameter	Symbol	Test Conditions	Min	Typ	Max	Unit
<b>SWITCHING CHARACTERISTICS</b>						
Turn-On Delay Time	$t_{d(ON)}$	$V_{GS} = -3/18\text{ V}$ , $V_{DD} = 400\text{ V}$ , $I_D = 20\text{ A}$ , $R_G = 4.7\ \Omega$ , $T_J = 175^\circ\text{C}$ (Notes 6 and 7)	-	11	-	ns
Turn-Off Delay Time	$t_{d(OFF)}$		-	45	-	
Rise Time	$t_r$		-	29	-	
Fall Time	$t_f$		-	14	-	
Turn-On Switching Loss	$E_{ON}$		-	173	-	$\mu\text{J}$
Turn-Off Switching Loss	$E_{OFF}$		-	64	-	
Total Switching Loss	$E_{TOT}$		-	237	-	

## SOURCE-TO-DRAIN DIODE CHARACTERISTICS

Forward Diode Voltage	$V_{SD}$	$I_{SD} = 20\text{ A}$ , $V_{GS} = -3\text{ V}$ , $T_J = 25^\circ\text{C}$	-	3.9	6.0	V
		$I_{SD} = 20\text{ A}$ , $V_{GS} = -3\text{ V}$ , $T_J = 175^\circ\text{C}$ (Note 7)	-	3.6	-	
Reverse Recovery Time	$t_{RR}$	$V_{GS} = -3\text{ V}$ , $I_S = 20\text{ A}$ , $di/dt = 1000\text{ A}/\mu\text{s}$ , $V_{DS} = 400\text{ V}$ , $T_J = 25^\circ\text{C}$ (Note 7)	-	20	-	ns
Charge Time	$t_a$		-	11	-	
Discharge Time	$t_b$		-	9	-	
Reverse Recovery Charge	$Q_{RR}$		-	95	-	nC
Reverse Recovery Energy	$E_{REC}$		-	6.9	-	$\mu\text{J}$
Peak Reverse Recovery Current	$I_{RRM}$		-	9.8	-	A

Product parametric performance is indicated in the Electrical Characteristics for the listed test conditions, unless otherwise noted. Product performance may not be indicated by the Electrical Characteristics if operated under different conditions.

6. EON/EOFF result is with body diode.

7. Defined by design, not subject to production test.

TYPICAL CHARACTERISTICS

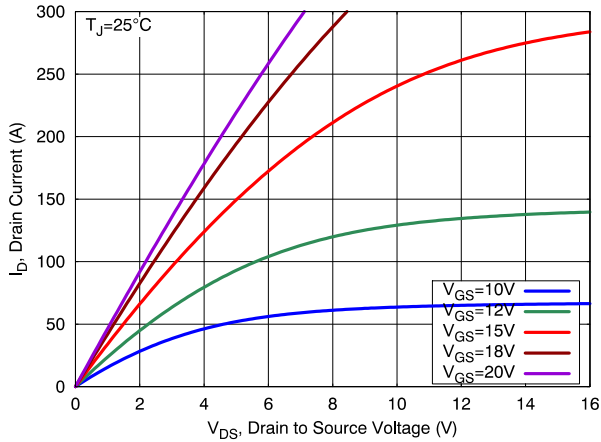


Figure 1. Output Characteristics

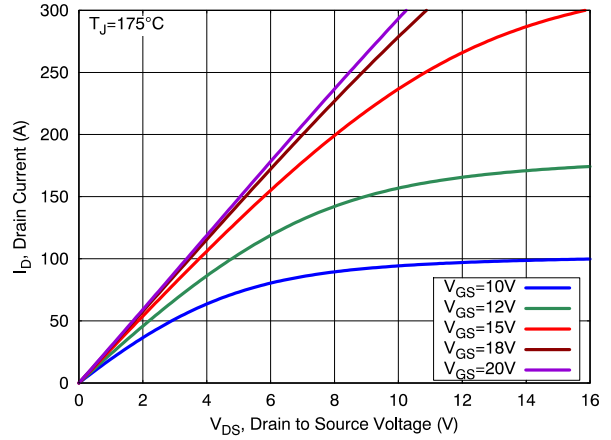


Figure 2. Output Characteristics

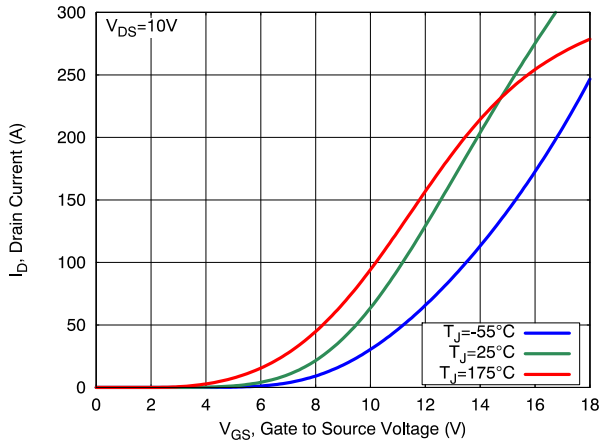


Figure 3. Transfer Characteristics

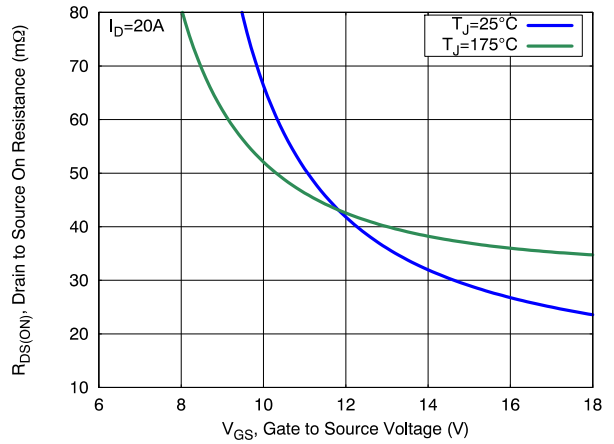


Figure 4. On-Resistance vs Gate Voltage

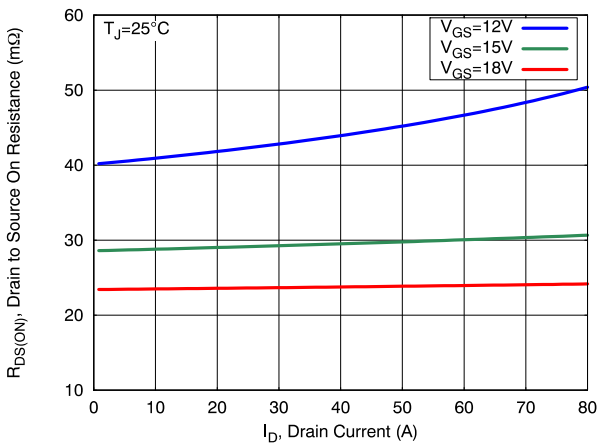


Figure 5. On-Resistance vs Drain Current

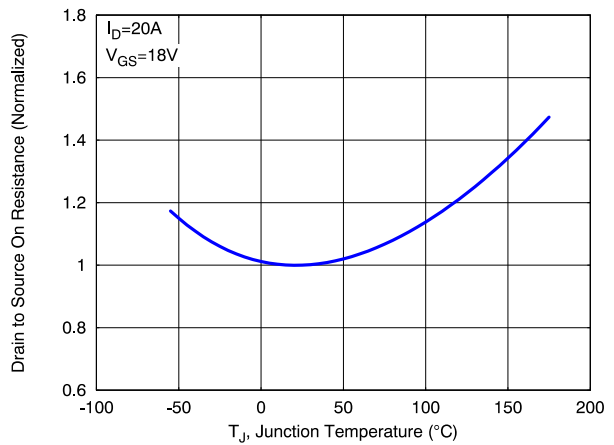


Figure 6. On-Resistance vs Junction Temperature

# NVHL023N065M3S

## TYPICAL CHARACTERISTICS

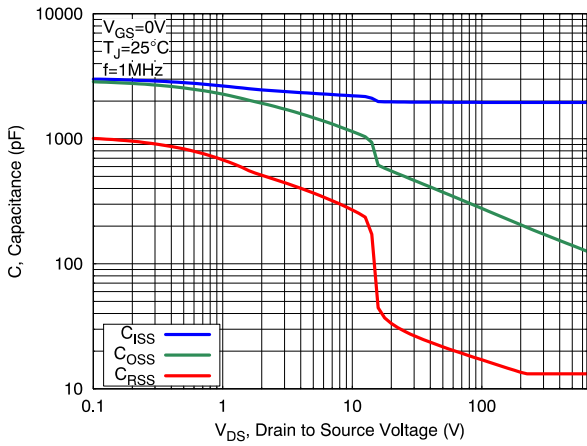


Figure 7. Capacitance Characteristics

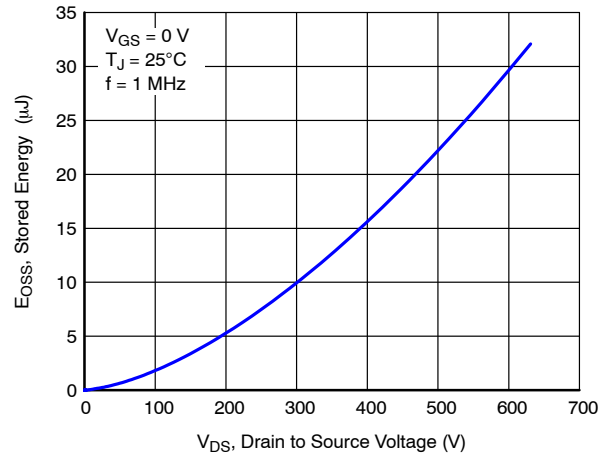


Figure 8. Stored Energy vs Drain to Source Voltage

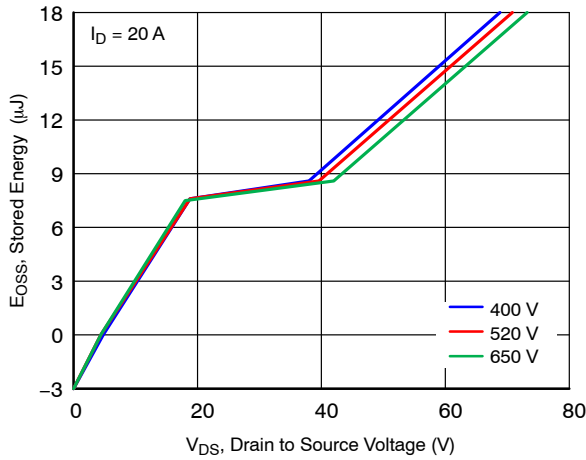


Figure 9. Gate Charge Characteristics

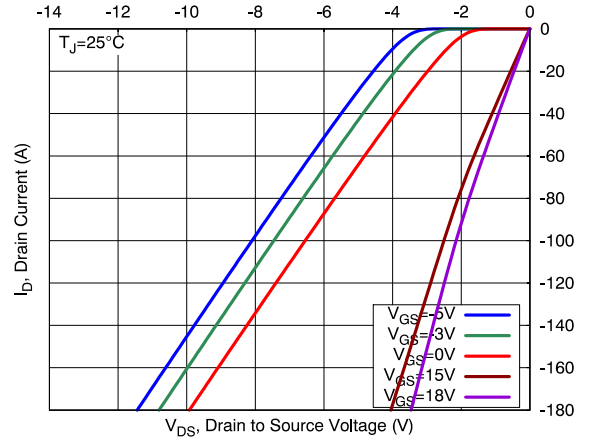


Figure 10. Reverse Conduction Characteristics

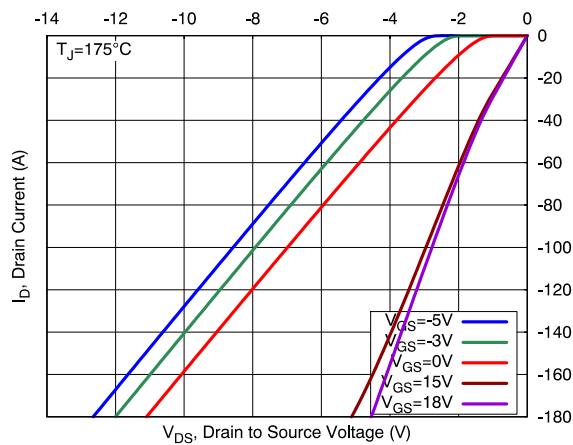


Figure 11. Reverse Conduction Characteristics

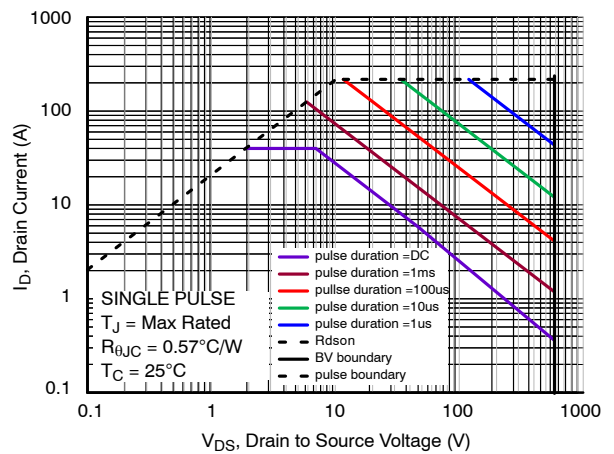
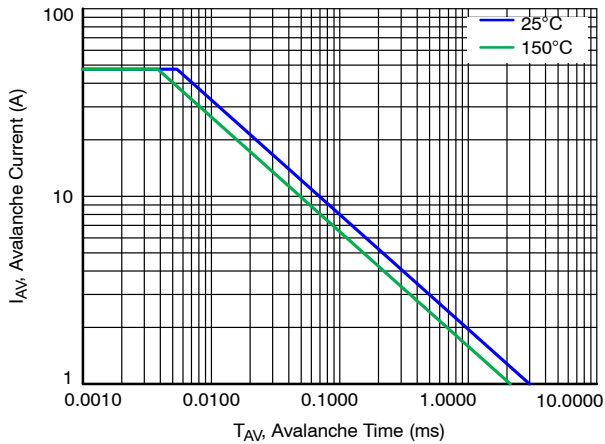


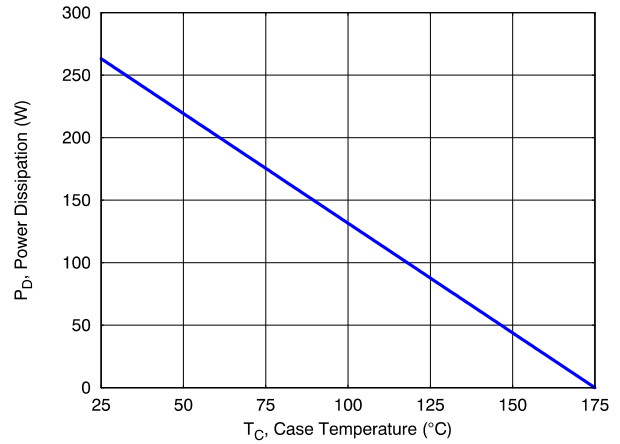
Figure 12. Safe Operating Area

# NVHL023N065M3S

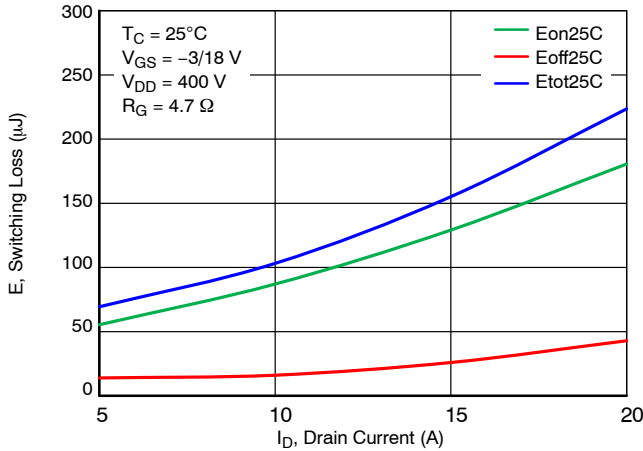
## TYPICAL CHARACTERISTICS



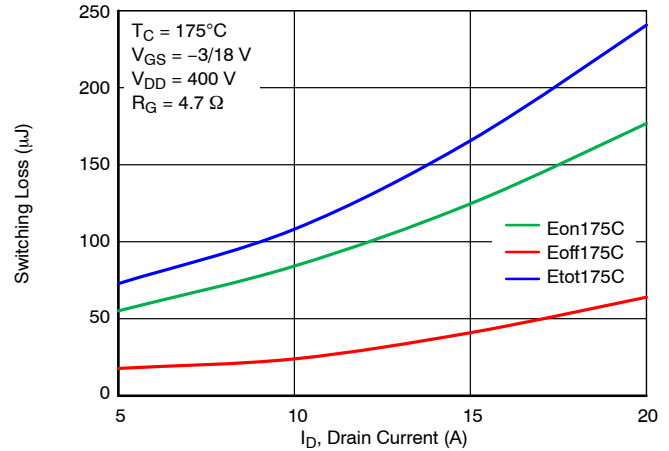
**Figure 13. Avalanche Current vs Pulse Time (UIS)**



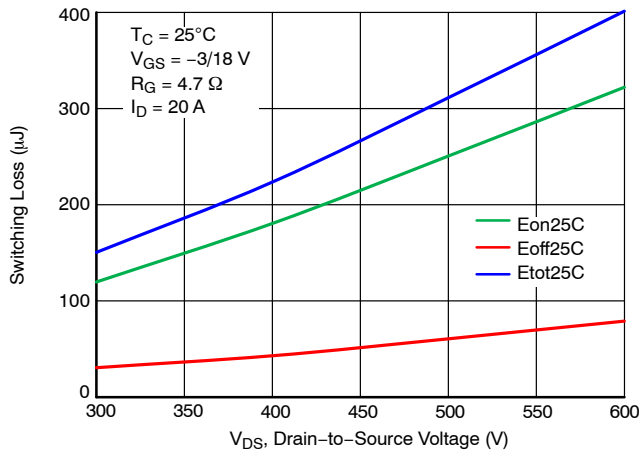
**Figure 14. Maximum Power Dissipation vs Case Temperature**



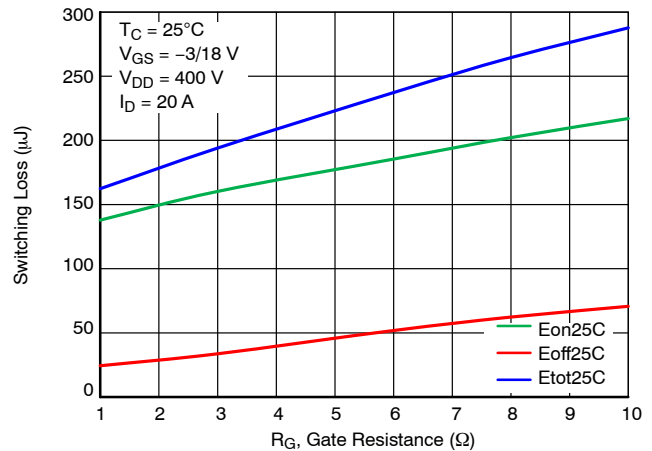
**Figure 15. Inductive Switching Loss vs Drain Current**



**Figure 16. Inductive Switching Loss vs Drain Current**



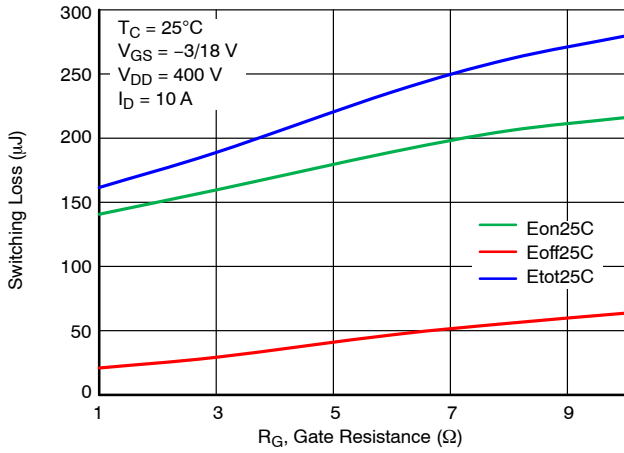
**Figure 17. Inductive Switching Loss vs Drain Voltage**



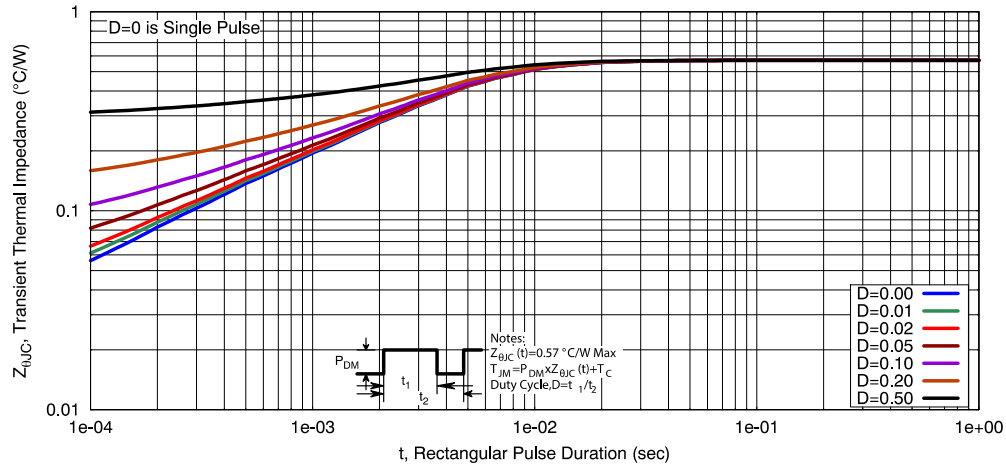
**Figure 18. Inductive Switching Loss vs Gate Resistance**

# NVHL023N065M3S

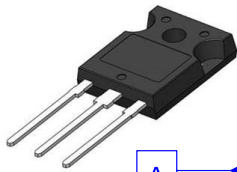
## TYPICAL CHARACTERISTICS



**Figure 19. Inductive Switching Loss vs Gate Resistance**

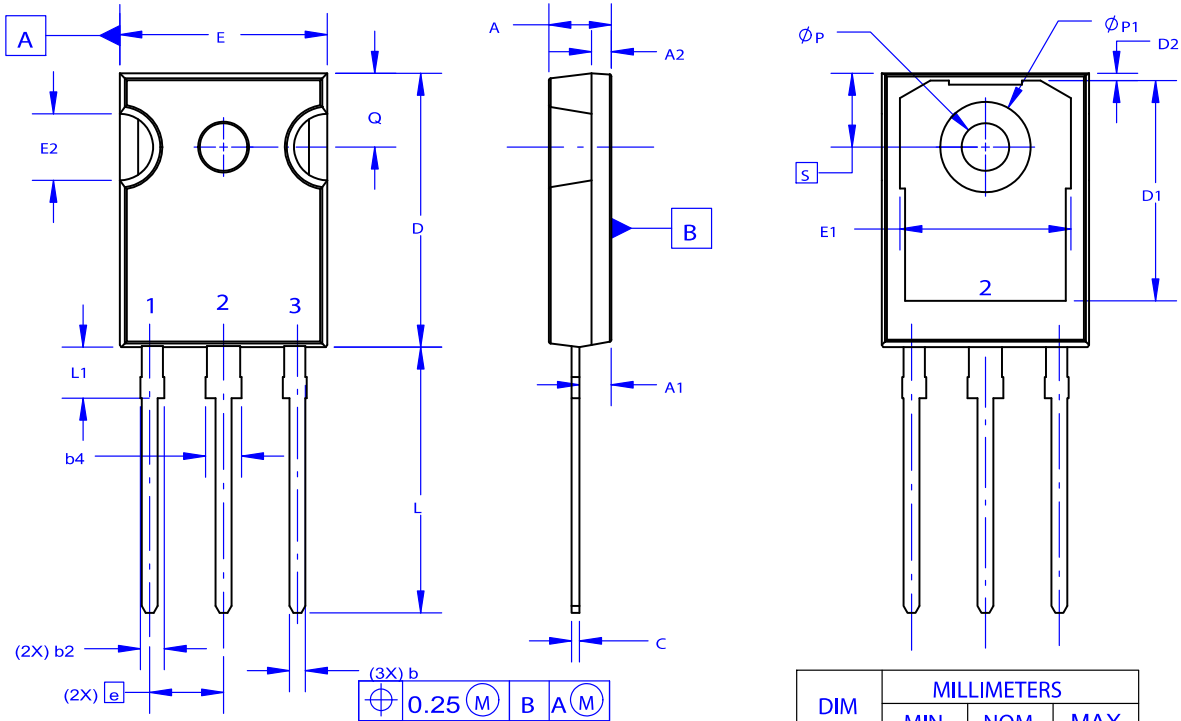


**Figure 20. Thermal Response Characteristics**



TO-247-3LD  
CASE 340CX  
ISSUE A

DATE 06 JUL 2020



NOTES: UNLESS OTHERWISE SPECIFIED.

- A. DIMENSIONS ARE EXCLUSIVE OF BURRS, MOLD FLASH, AND TIE BAR EXTRUSIONS.
- B. ALL DIMENSIONS ARE IN MILLIMETERS.
- C. DRAWING CONFORMS TO ASME Y14.5 - 2009.
- D. DIMENSION A1 TO BE MEASURED IN THE REGION DEFINED BY L1.
- E. LEAD FINISH IS UNCONTROLLED IN THE REGION DEFINED BY L1.

DIM	MILLIMETERS		
	MIN	NOM	MAX
A	4.58	4.70	4.82
A1	2.20	2.40	2.60
A2	1.40	1.50	1.60
D	20.32	20.57	20.82
E	15.37	15.62	15.87
E2	4.96	5.08	5.20
e	~	5.56	~
L	19.75	20.00	20.25
L1	3.69	3.81	3.93
ØP	3.51	3.58	3.65
Q	5.34	5.46	5.58
S	5.34	5.46	5.58
b	1.17	1.26	1.35
b2	1.53	1.65	1.77
b4	2.42	2.54	2.66
c	0.51	0.61	0.71
D1	13.08	~	~
D2	0.51	0.93	1.35
E1	12.81	~	~
ØP1	6.60	6.80	7.00

GENERIC MARKING DIAGRAM\*



- XXXXX = Specific Device Code
- A = Assembly Location
- Y = Year
- WW = Work Week
- G = Pb-Free Package

\*This information is generic. Please refer to device data sheet for actual part marking. Pb-Free indicator, "G" or microdot "▪", may or may not be present. Some products may not follow the Generic Marking.

DOCUMENT NUMBER:	98AON93302G	Electronic versions are uncontrolled except when accessed directly from the Document Repository. Printed versions are uncontrolled except when stamped "CONTROLLED COPY" in red.
DESCRIPTION:	TO-247-3LD	PAGE 1 OF 1

onsemi and Onsemi are trademarks of Semiconductor Components Industries, LLC dba onsemi or its subsidiaries in the United States and/or other countries. onsemi reserves the right to make changes without further notice to any products herein. onsemi makes no warranty, representation or guarantee regarding the suitability of its products for any particular purpose, nor does onsemi assume any liability arising out of the application or use of any product or circuit, and specifically disclaims any and all liability, including without limitation special, consequential or incidental damages. onsemi does not convey any license under its patent rights nor the rights of others.



**onsemi**, **Onsemi**, and other names, marks, and brands are registered and/or common law trademarks of Semiconductor Components Industries, LLC dba "**onsemi**" or its affiliates and/or subsidiaries in the United States and/or other countries. **onsemi** owns the rights to a number of patents, trademarks, copyrights, trade secrets, and other intellectual property. A listing of **onsemi**'s product/patent coverage may be accessed at [www.onsemi.com/site/pdf/Patent-Marking.pdf](http://www.onsemi.com/site/pdf/Patent-Marking.pdf). **onsemi** reserves the right to make changes at any time to any products or information herein, without notice. The information herein is provided "as-is" and **onsemi** makes no warranty, representation or guarantee regarding the accuracy of the information, product features, availability, functionality, or suitability of its products for any particular purpose, nor does **onsemi** assume any liability arising out of the application or use of any product or circuit, and specifically disclaims any and all liability, including without limitation special, consequential or incidental damages. Buyer is responsible for its products and applications using **onsemi** products, including compliance with all laws, regulations and safety requirements or standards, regardless of any support or applications information provided by **onsemi**. "Typical" parameters which may be provided in **onsemi** data sheets and/or specifications can and do vary in different applications and actual performance may vary over time. All operating parameters, including "Typicals" must be validated for each customer application by customer's technical experts. **onsemi** does not convey any license under any of its intellectual property rights nor the rights of others. **onsemi** products are not designed, intended, or authorized for use as a critical component in life support systems or any FDA Class 3 medical devices or medical devices with a same or similar classification in a foreign jurisdiction or any devices intended for implantation in the human body. Should Buyer purchase or use **onsemi** products for any such unintended or unauthorized application, Buyer shall indemnify and hold **onsemi** and its officers, employees, subsidiaries, affiliates, and distributors harmless against all claims, costs, damages, and expenses, and reasonable attorney fees arising out of, directly or indirectly, any claim of personal injury or death associated with such unintended or unauthorized use, even if such claim alleges that **onsemi** was negligent regarding the design or manufacture of the part. **onsemi** is an Equal Opportunity/Affirmative Action Employer. This literature is subject to all applicable copyright laws and is not for resale in any manner.

## ADDITIONAL INFORMATION

### TECHNICAL PUBLICATIONS:

Technical Library: [www.onsemi.com/design/resources/technical-documentation](http://www.onsemi.com/design/resources/technical-documentation)  
onsemi Website: [www.onsemi.com](http://www.onsemi.com)

### ONLINE SUPPORT: [www.onsemi.com/support](http://www.onsemi.com/support)

For additional information, please contact your local Sales Representative at [www.onsemi.com/support/sales](http://www.onsemi.com/support/sales)